

# Evergreen



number 10  
march 1983



Newsletter of  
**Kerala Forest  
Research Institute**

**Evergreen, the KFRI Newsletter** is currently brought out in March and September each year and is intended for free private distribution within the Institute and the Kerala Forest Department. Free copies will also be sent, upon request to other persons or institutions connected with forestry activities. The views expressed here are those of the authors and do not necessarily reflect views of the Institute. All interested persons are invited to send comments, opinions and short articles for inclusion in **Evergreen**. The Newsletter Committee reserves the right to choose among contributions and edit, when necessary. Address all communications to:

Editor, **Evergreen**  
Kerala Forest Research Institute,  
Peechi 680 653.



**kerala forest  
research institute**

**Newsletter Committee  
(1983 - 1984)**

**J. K. Sharma (Editor)**  
**S. K. Ghosh**  
**N. Gopalakrishnan Nair**  
**Mathew P. Koshy**

## Eucalyptus and Social Forestry

More than a century ago when *Eucalyptus globulus* was planted on trial basis in Nilgiri hills by Captain Cotton of Madras Engineers he probably did not foresee that eucalypts will not only become an integral part of plantation forestry in India but also a tree for rural people. In recent years eucalypt, a native of Australia, has gained worldwide importance due to its fast growth and multiple end uses. Though some criticisms of monoculture of exotic eucalypts can be heard off and on from some quarters and suggestions for its replacement with some other indigenous species, they have made their place secure in the plantation forestry with no point of return. However, introduction of eucalypts in social forestry programmes has raised some controversies. The objectives of social forestry, as defined by the National Commission on Agriculture (NCA, 1976) are: (a) supply of fuelwood to replace cowdung; (b) supply of small timber; (c) supply of fodder; (d) protection of agricultural fields from wind and soil erosion; and (e) creation of recreational amenities. After intensification of social forestry activities under National Rural Employment Programme (NREP) nurseries of various species including those of eucalypt are being raised throughout Kerala and seedlings distributed free of cost to people. What is surprising is that while other species, as *Xylocarpus xylocarpa*, *Melia dubia*, *Albizia falcataria*, *Bombax ceiba*, *Gmelina arborea*, *Grevillea robusta*, *Swietenia mahagoni*, *Ailanthus triphysa*, *Cassia fistula*, *Delonix regia*, *Casurina equisetifolia*, *Tamarindus indica* and *Leucaena leucocephala* are in great demand, thousands of seedlings of eucalypts are left in nurseries unwanted. Is it not a colossal wastage of resources? Now the question comes up—why people are apprehensive of eucalypt seedlings? Is it because of the general notion that it drains out too much water from the soil through excessive transpiration or does it have long term impact on the fertility of agricultural lands. Though eucalypt plantations have been raised in India for more than three decades their impact on soil and water conservation or influence on the water table is still a controversial subject. Some eucalypts, especially *E. camaldulensis*, appear to have the capacity to lower the water table as they have been successfully used in reclaiming the swampy areas in Turkey and Israel. This capacity of eucalypt gets some scientific support from a recent

study in Australia on *E. marginata*, indicating the capability of this species in exploiting much of the water stored deep in the soil due to the low leaf water potential with high transpiration rate even under stress during dry season (This atleast partly explains the successful adoption of these evergreen eucalypts to their natural environment). However, extensive plantings of *E. teretecornis* along the roadside, railway track, canal banks and agriculture field boundaries in Punjab, Haryana, Gujarat and Uttar Pradesh do not seem to affect the high yielding wheat crops which are grown in the neighbouring fields (Unasylva 31 (125):19-24 (1979). But it may not be justified to attach any significance to this circumstantial evidence especially in the absence of relevant scientific data on eucalypts, commonly grown in India. A deliberate attempt has to be made to bring out the truth about the impact of eucalypts on ground water and soil fertility. KFRI can play an important role in this direction by providing the facts to the users, originating from systematic studies.

The choice of eucalypt as a farm tree has been motivated by a single criterion—the maximum production of wood in the shortest possible time. If the controversy regarding the water conserving capacity of eucalypts is settled by intensive research, then the question arises whether eucalypt, with all the advantages (fast growing, not browsed by animals) and disadvantages (leaves of eucalypts do not provide any fodder or green manure as other traditional trees or do not contribute to the building up of humus and fast burning rate of wood), is the right species for social forestry? But do we have an alternative species which can meet all the requirements of rural people and face the challenge of firewood crisis? It is not too late to give a serious thought on the selection of species depending upon the needs of the people. For achieving the goals of social forestry a judicious choice of species is of vital importance.

— o —

With this issue of Evergreen we are introducing two new features: Focus—which includes abstracts of selected research articles of general forestry interest from current journals, and Divisional highlights—which gives an insight into the scope of the Division in relation to forestry and their current research activities.

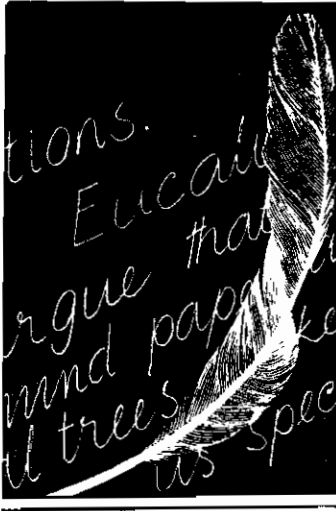

O  
P  
I  
N  
I  
O  
N  
P  
A  
G  
E

The Editor

I was interested to read your editorial "Do we need exotic forest trees?" We are soon to rewrite our book on leucaena (Ipil-Ipil). Could you send information about it in Kerala, where you say its growth is stunted in most places? This would be important for us to document.

Noel D. Vietmeyer

P. S. Saturnia Halos put too gloomy a title on her article, *Leucaena* ofcourse is not miraculous but it is still growing extremely well in many parts of the Philippines ..... India too I think.

(Letter from Mr. Noel D. Vietmeyer, Commission of International Relations, National Academy of Sciences, 2101 Constitution Avenue, Washington, D.C. 20418, U. S. A.).

**DR. S. KEDHARNATH JOINS AS DIRECTOR**



Dr. S. Kedharnath FNA, formerly Director of Biological Research, FRI & Colleges has joined KFRI on 18 October 1982.

Dr. S. Kedharnath, a renowned forest geneticist and fellow of Indian National Science Academy, started his career in the year 1946, after his M. Sc. from Madras University. Till 1955 he worked on breeding of crop plants like wheat, linseed, sesame, chillies and bengal gram. After securing his Ph. D. in Genetics from the University of Wisconsin in 1957 he joined FRI & Colleges, Dehra Dun as head of the Forest Genetics branch in 1959. He held this position with great competence and distinction for nearly two decades and retired as the

Director of Biological Research. He has 63 scientific papers to his credit. In recognition of his scholarship and meritorious contribution to the cause of forestry a special commemorative volume entitled "Advances in Forest Genetics" was brought out in the year 1980.

KFRI looks forward to a bright future under his leadership.

## Division of Botany (Plant Physiology)

Study of various phenomena related to growth and development of plants like photosynthesis, respiration, absorption and translocation of water and nutrients, transpiration, growth and reproduction, nitrogen, lipid and fat metabolisms, etc. comes under the domain of the Division of Plant Physiology. Trees, due to their larger size and longer span of life have special physiological problems. The principal difference from herbacious plants is the greater distance over which water and minerals must be translocated and also in the larger percentage of non-photosynthetic tissue. A proper understanding of the physiological requirements of different tree forms is essential to predict, to a certain extent, as to how a particular species will grow in a particular geographical area/locality or will respond to a specific treatment.



Fig. 1. A rooted branch cutting of *Tectona grandis* (4 months after treatment)

One important problem in horticulture or forestry is the production of adequate quantity of genetically improved planting stock. For this vegetative propagation by rooted stem cuttings is one of the methods which can be used for producing propagating material of genetic uniformity in bulk. Vegetative propagation is advantageous for plants whose seeds germinate either slowly or poorly or

plants that have a long juvenile period during which they do not produce flowers, fruits and seeds. In this regard only limited attempts are made in tropical trees and there is no standard technique of vegetative propagation for many of the timber tree species. Hence as a first step, the Physiology Division has undertaken studies on vegetative propagation of some important timber species, like *Tectona grandis* L. f., *Melia dubia* Cav., *Xylia xylocarpa* (Roxb.) Taub., *Hopoe parviflora* Bedd., *Swietenia mahogoni* (L.) Jacq. and *Gmelina arborea* Roxb.

In preliminary investigations promising results have been found with growth regulating substances such as indole acetic acid (IAA) indole butyric acid (IBA) and naphthyl acetic acid (NAA) and some other chemicals like coumarin and boric acid to induce rooting in many cases (Fig. 1). For inducing rooting in stem cuttings of these species attempts are being made to standardize the technique by either using growth regulating substances alone or in combi-



Fig. 2. A rooted cuim cutting of *Bambusa arundinacea* (1 year after treatment)



nation at different concentrations. Cuttings are being planted at monthly intervals to note the seasonal effect on rooting. Methods are also being developed to conduct these trials under controlled conditions of humidity, light and temperature.

In the case of bamboos, the conventional method of raising plantations is from offsets or seeds. Since most of the bamboos produce seeds only twice or thrice a century, possibility of raising plantation from seeds is very limited. Planting offsets is even more difficult because of the problems of extraction and transport. As there is no easy and practical method of vegetative propagation of bamboos and reeds extensive trials were conducted to induce rooting in culm and branch cuttings of different species using growth regulating substances and the results are encouraging (Figs. 2 and 3). Depending upon the season, growth regulating substance used, and nature of the cutting, 60-80% of the culms cuttings rooted. Compared to culm cuttings the percentage of rooting was low (30-40%) in the case of branch cuttings. Two noded culm cuttings had one more advantage that rooting occurred at both the nodes so that they could be separated to two plants while transplanting. Such rooted cuttings planted in the field have established well. The different species tried so far are: *Bambusa balcooa* Roxb., *B. arundinacea* Willd., *B. polymorpha* Munro, *B. vulgaris* Schrad., *Dendrocalamus strictus* Nees, *Ochlandra travancorica* Gamble, and *O. scriptoria* C.E.C. Fisher.



Fig. 3. A rooted culm cutting of *Ochlandra travancorica* (1 year after treatment)

(Continued on page 7)

## Plants of Current Interest

(In the light of the September issue (No. 9) of Evergreen where 'The firewood crisis' (Editor's column) and 'Fuel from live trees' were featured, three plants, which are being exploited in different parts of the world as the potential source of energy are presented here for the benefit of readers - Ed.)

### Miracle Oil

*Simmondsia chinensis* L. (Family - Simmondsiaceae; Jojoba - pronounced Ho-Ho-ba), a Californian desert shrub, which can thrive on as little as 750 mm of rainfall and tolerates salty conditions, produces an oil from its beans, comparable to sperm-whale oil. The oil can be used as a lubricant or when mixed with alcohol, as a fuel. The fuel crisis in the U. S gave a start to make extensive planting of this plant in semi-arid conditions. An unusual feature of *Simmondsia* is the storage and mobilization of waxes in the seed, instead of the usual carbohydrates, proteins or fats. (Canopy 7(12), 1981)

### Petroleum nut

The Bureau of Plant Industry in the Philippines is proposing a five year plan research programme costing \$ 1.3 million to propagate *Pittosporum resiniferum* Hemsl. (Fam. Pittosporaceae), a tree endemic to Philippines. It grows to a height of 12 m, fruits twice an year and the odour of the oil from its nuts resemble that of petroleum. Locally known as 'petroleum nuts' (even the fresh green fruits burns brilliantly!), 400 of them weigh a Kg. which yields 70 gms of oil and is used for burning lamps. (Modern Power Systems, Jan. 1982).

### Jatropha

The Agriculture Engineering Division in Thailand has come up with a substitute for diesel engine oil - the seed oil of *Jatropha curcas* L. Tests at the Thai Farm Machinery Centre is reported to have given very satisfactory results with this oil on diesel engines. A native of Tropical America, *Jatropha curcas* L. (Fam. *Euphorbiaceae*) is used as a hedge plant and is called 'Kattavanakku' in Malayalam. The seed oil is used for the manufacture of soaps and candles. (Reric News 5(2), Aug. 82).

# Scope of Forestry Education and Training in India



Sri. K. M. Tiwari, President, Forest Research Institute and Colleges, Dehra Dun and also a member of the Governing body of KFRI was interviewed on 2nd February by Dr. C. T. S. Nair, Dr. S. K. Ghosh and Dr. J. K. Sharma on behalf of Evergreen. Excerpts from the interview are given here.-Ed.

**Evergreen:** Since you have been closely associated with forestry for many years would you please tell us whether you are satisfied with the standard of forestry education and training in India?

**K. M. T.:** I am satisfied with the training part of it, but certainly not with the education part. In our country, forestry, education and training go side by side. In many other professions, for example in the Indian Administrative Service they are separated, and training is imparted after education. It would be better, if the Agricultural Universities look after the education part of forestry. We would also like to see that FRI and its colleges obtain the status to award degrees so that it could open its door to those wishing to do their higher education at the doctoral and post-doctoral levels.

**Evergreen:** With the concepts of social and Agroforestry coming to the forefront, what changes do you envisage in the pattern of education and training in forestry?

**K. M. T.:** What comes to my mind first is the extension part of forestry education, which we lack very badly. Hitherto, we have not succeeded in carrying the message of tree planting to the people properly. And this is the failure of our system. Our young foresters should be exposed more to the real problems of villagers. Forestry curriculum should be revised to fulfil this objective. Steps are being taken to formulate a very comprehensive syllabi for tribal welfare education to be introduced at all levels of forestry training.

**Evergreen:** Recruitment to the forestry service is done primarily from among those with education in biological sciences. Implementation of social forestry programmes requires more emphasis on social sciences such as Economics, Sociology etc. Do you intend to modify the recruitment policy accordingly?

**K. M. T.:** For the present, we are not contemplating any change in this respect. This is the responsibility of the Ministries of Home and Agriculture. Many of the probationers in the IFS have some exposure to social forestry and forest economics. If

---

**In Forestry the research component has not acquired so much importance as in the field of Agriculture. Here it reached much later and the devastation of most of our forests brought research to the forefront.**

---

the purpose is not being fulfilled by the usual foresters then the Government will have to give special consideration to bring in sociologists and economists into the service.

**Evergreen:** Some of the Universities in India have already started courses in forestry. What will be the scope of employment for such graduates? Will they be directly absorbed to the forest service?

**K. M. T.:** No, getting a degree in forestry is not a sufficient condition for absorption in the forest service. There is a system of recruitment and forestry graduates too will have to undergo that, like that in the Engineering Services. They will find their

place according to their merit in the Forest Service Exams.

**Evergreen:** Unless the recruitment rules are changed, the employment chances for graduates in forestry will be limited. Under such condition, will any University start a course in forestry?

**K. M. T.:** One must appreciate that the scope of forestry is not limited. With the emphasis given to both forest industries and social forestry, there is a gradual increase in the employment potential. Moreover, many of the companies are employing foresters for extension work and raising their own plantations.

**Evergreen:** In countries like Canada and Australia only forestry graduates are employed by the State Forest Departments, while here science graduates with some training in forestry are absorbed in the Forest service. Do you consider the short training given now is adequate for the duties they perform?

**K. M. T.:** See, in affluent countries the problem is to get sufficient manpower for various jobs, but here it is different. We have excess of manpower for many of the jobs available. We give sufficient exposure to biological sides of forestry to non-biologists and non-biological aspects to biologists. We are satisfied with the present selection procedure.

**Evergreen:** Isn't it possible for an understanding between Universities and the State Forest Department to solve the unemployment problem of forestry graduates?

**K. M. T.:** First of all I do not know whether it is possible to guarantee employment to all forestry graduates. Such a provision is not in existence anywhere even in the case of medicine. But there is tremendous scope in private sector as well as public sector undertakings. For example Kumaun University graduates were employed by U. P. Forest Development Corporation as logging officers. With the execution of Social Forestry programmes there will be more opportunities and the forestry graduates can take their place according to their talent. But we can never say that there will be no unemployment among forestry graduates. Otherwise we have to adopt a closed system, as we have at the moment, in which training is limited to that number, which is required according to the strict calculation of the cadre management. This also will have other problems, such as scarcity of trained hands. A synthesis is to be brought about with the advantages of both. Anyway there is a reasonable assurance with the developing economy.

**Evergreen:** Do you expect any rapid expansion of forestry in the private sector?

**K. M. T.:** Not much in silvicultural aspects. In the utilization of forestry produce there is a bit of expansion say, in rural cottage industries, in medium and large size industries. With the increase in social activities under social and farm forestry programmes raw material availability will increase and this will encourage in setting up of more processing units in the private sector.

**Evergreen:** A major draw back in the existing system of forestry training is that, a person after getting his diploma from the forest college seldom gets an opportunity to update his knowledge at a later stage. Does FRI have any plans to conduct refresher courses for forestry personnels at different levels?

**K. M. T.:** Yes. FRI is very much concerned with it. Last year we commenced a refresher course inviting applications from the states. The response has been very poor and we were not able to conduct the course. Anyway, I intend to pursue the matter.

---

**Tree growing is our concern; and if by politics you can grow trees, yes, go for politics also.**

---

This will be a regular programme. We are proposing to run refresher courses one at the 8th year of the service and another at the 15th year. Unless we have enough exposure to present trends and needs we will be left far behind.

**Evergreen:** Most of the Foresters in the field have to reckon with a number of administrative and political problems rather than to technical ones. Doesn't this affect their professional calibre?

**K. M. T.:** You are mistaken. We have nothing to do with politics. Tree growing is our concern, and that is our politics. If by politics you can grow trees, yes, go for politics also.

**Evergreen:** Do you intend to introduce a degree course at FRI?

**K. M. T.:** Very much. We are requesting the Government of India to make FRI an institute of international importance.

**Evergreen:** Don't you expect the forestry graduates to perform better than those pure science graduates with diploma course?



**K. M. T.:** During the 2 years training we give to science graduates, we are exposing them to the different aspects of forest management. But for the future needs in forestry, I feel, there should be some more training.

**Evergreen:** Won't it be preferable to admit only post graduates to the IFS training, as they do in the Agricultural Research Service. Don't you think that it may help to narrow down the communication gap between the forestry researchers and forestry practitioners?

**K. M. T.:** Well, I quite agree with you. But in forestry, the research component has not acquired so much importance as in the field of Agriculture. Even in such an important sector like Agriculture, the Research Service is only 7 years old. In the field of Forestry, research reached much later, and the devastation of most of our forests brought research to the forefront. We are working out a scheme for a Central Forestry Research Service in which there will be some provision for inducting the professional IFS people and the State Forest Service people also.

---

#### DIVISION OF BOTANY (Plant Physiology)

(From Page 4)

Due to their larger size and longer juvenile period tree breeding requires great deal of patience and time. In the case of some coniferous families (Cupressaceae and Taxodiaceae) precocious flowering (before the age of natural flowering) has been reported to be induced repeatedly and reliably with gibberellins. However only limited work has been done in broad leaved plants. Recently the division has initiated some work on this aspect in teak and eucalypts. In teak the objective is to induce precocious flowering whereas in eucalypts it is to bring about synchronization of flowering times of different species to facilitate interspecific hybridization.

Division of Botany  
(Plant Physiology)

A Practical hint

### HOW DO YOU FIX A SIGN BOARD TO A LIVE TREE?

**By nail?** Due to girth increment the nail may get immersed into the bark and give away the board.

**By a tight wire?** The wire also may get immersed in the bark and result in the girdling of the tree or even break leaving the board bent or displaced

Then why not this way:-

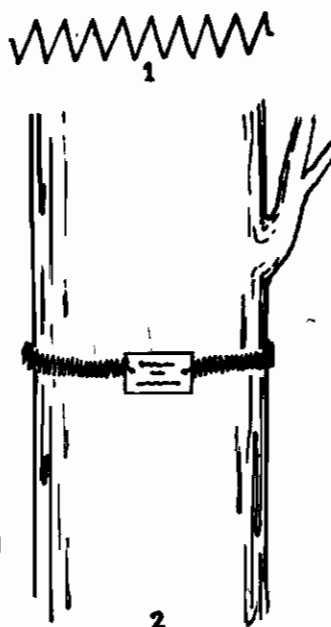

Take a piece of GI wire of appropriate gauge (depending upon the weight of the board) having a length three times the tree's girth. Plait the wire as shown in fig. 1 making two hooks at the ends.

Tie the plaited wire around the tree and fix the board to the hooks as shown in fig. 2. As the tree grows the wire will stretch, without inflicting any harm to the tree and the board will also remain intact.

K. C. Chacko  
Silviculture Division

### AND WHEN.....

And when Man burned down the trees  
The soul of the dead wood wept into  
the stream and told,  
'You will soon be dry and  
with your dryness all will die'  
And then the stream said back,  
'Nothing to worry about any,  
in deserts too they live.'  
'But when will they all die?'  
asked the soul with a grin.  
'When the oceans get dry'  
Said the Stream and flowed on.

N. Gopalakrishnan Nair  
Division of Botany (Taxonomy)

# FOCUS

**Deforestation** in India has caused severe ecological damage and brought untold social misery. To combat this, the Indian Government has adopted an ambitious programme of 'social forestry, the aim being to rebuild the country's forest wealth through the active participation of village communities. But despite the radical objective, the programme has turned out to be little more than an extension of earlier forestry practices. In practice social forestry has failed to achieve almost all of its objectives. At the root of this failure lies a commitment in trying to satisfy human needs through the operation of the market economy. Industry has benefited and the losers are the rural poor. (The Ecologist 12 (4): 158-168, 1982).

**Nutrient removals** for short rotation eucalypt plantations are greater than removals for saw log production from native eucalypt forests but less than removal under agriculture. The leaves of ten-year-old short rotation plantations account for around 18% of the total tree nutrients and bark accounts for 13% to 58%, which together they only comprise 18% of the biomass. The harvesting of the total tree will therefore cause a disproportionate increase in nutrient removal over that from harvesting stem wood only. In particular, nitrogen, phosphorus and potassium removal will be markedly increased. However nutrient removal and nutrient replacement costs are not likely to have a major bearing on the economics of short rotation plantation (Australian Forestry 44 (3): 142-152, 1981)

**Forest monocultures-How safe are they?** An entomologist's view: The widely held belief that pest risks are disastrous in a forest monoculture is refutable. In the literature generalization on the rule and specific examples to support the argument are few and far between. Although pest outbreaks, are often regarded as a general consequence of reducing diversity through monoculture, it is surprisingly hard to find documented examples. Most of the arguments refer to natural system and not to man made or artificial communities. There is a wealth of literature available on the stability / diversity relationships of man made communities but with very few exceptions this deals with agroecosystems. Utmost care is needed in drawing conclusions from these types of situations and applying them to forests which have much longer time scale. In conclusion it may be said that pest outbreak in artificially established stands are no more common than they are in natural forests. (N. Z. Jour. of For. 26 (1): 37-42, 1981)

A pathologist's view. An argument that disease risks are more in large scale monocultures gains little support from a critical survey of the literature. No clear evidence has been found to correlate outbreaks of disease in pure stands to lack of species diversity; serious diseases have occurred in mixed and exploitable natural forests. An undisturbed natural forest or ecosystem may be stable within a certain period. The principles governing such stability are still little known, but it is certainly reasonable to assume that an understanding of such principles is highly important to our forestry practice. At present there is little reason to assume that any departure from "nature" must increase disease hazards. (N. Z. Jour. of For. 26 (1): 20-36, 1981).

**Site quality** has been effectively estimated by using height (H) and diameter (D) of dominant and codominant trees independent of tree age. Site and species parameters are used to define the H - D site curves. The estimated site parameters increase with increasing site index and are significantly different between site classes. The estimated species parameters are species specific and are not found to be significantly different between site classes. (Forest Science 28 (23): 639-645, 1982).

**The pipe model theory** presents the idea that a unit weight of tree foliage is serviced by a specific cross-sectional area of conducting sapwood in the crown. Below the crown a large fraction of the tree bole may be non-conducting tissue, so the sapwood area would have to be known to estimate foliage. This theory when applied to analyse whether the distribution of canopy leaf area could be accurately estimated from knowledge of the sapwood cross-sectional area at various heights, including breast height gave excellent results. (Can. J. For. Res. 12 (3): 556-560, 1982).

# Some Alternative Tools and Improved Techniques in Logging: I. Debarking

Logging, which involves planning, implementing and control of timber harvesting operations from felling site to mill, is an integral part of forestry. Logging generally, consists of the following sequential operations:

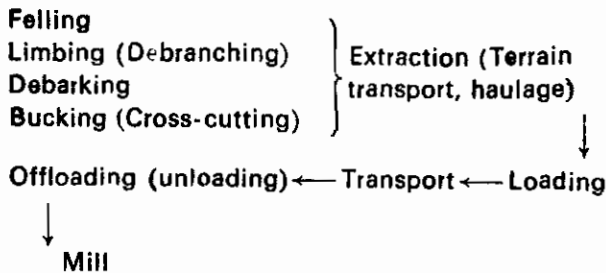

Though much scientific input has come into logging operations in developed countries, we are yet to modernize our system. Our present system of logging is not efficient because of the following reasons:

- (1) Most of the forest workers engaged in these activities are unskilled and not trained;
- (2) The tools used are of primitive type regardless of the job requirements; no attention is given in both designing and prescribing the tools to reduce wastage and increase productivity; tool maintenance is also poor;
- (3) The important aspects, such as ergonomics and safety of forest workers are almost ignored;
- (4) No serious consideration is given to the economical aspects of cost of production.

It is the concern of this communication to invite the attention of foresters and timber contractors to some improved but simple methods of logging. From the point of view of efficient logging, some of the newly designed tools for modern labour-intensive techniques for logging are chosen and described here. The present note confines only to debarking tools and techniques.

Today, traditional tools like axes and some kind of jungle knives are commonly used for debarking, but these tools have some disadvantages. While working with an axe it is cumbersome for the worker to remain in a stooped position for a long time. Secondly the chances of wood removal along with bark are also more with an axe. The jungle

knife would take much more time to complete the job than the axe. Specially designed tools described here are Debarking spud (for long logs) (Fig. 1) and Debarking knife (for short logs) (Fig. 2). These tools have considerable advantages over the traditional ones as being efficient, simple to work with and easy to fabricate locally. The working methodology of these tools is illustrated below in a series of diagrams (Figs. 3- 14) (by permission of a manufacturing company, FISKARS, Mannerheimintie 14 A, P.O. Box 235, SF. 00101 Helsinki 10, Finland). Technical details of the tools are given below:

1. **Debarking spud** - weight, 1.1 Kg; total length, 105.0 cm; blade width, 13.0 cm.

2. **Debarking knife** - weight, 600 g; total length, 58.0 cm; handle length, 13.5 cm; blade length, 30.0 cm; blade width, 3.5 cm

These tools have the following advantages over the local ones:

- 1) Debarking spud reduces the risk of laceration as compared to a jungle knife or an axe.
- 2) Debarking spuds and knives allow the workers to maintain semi-upright stance or straight-back working position rather than a stooped position.
- 3) The 'new' tools can be used both in difficult as well as soft terrain.
- 4) The tools ensure consistency in performance

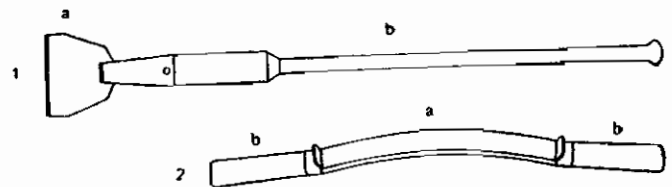

Fig. 1. Debarking spud; Fig 2. Debarking knife; (a. Blade, b. Handle)

provided they are manufactured from high quality, heat-treated steel (FISKARS) (5) As the worker gets good grip over the tool, the chances of wood wastage are less as compared to using axe. (6) The 'new' tools are designed for both right and left hand users.

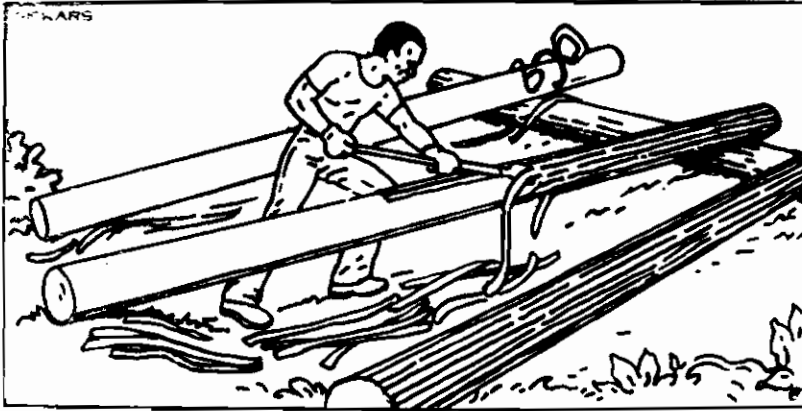

Fig. 3. Debarking is easier when the log is at knee level.

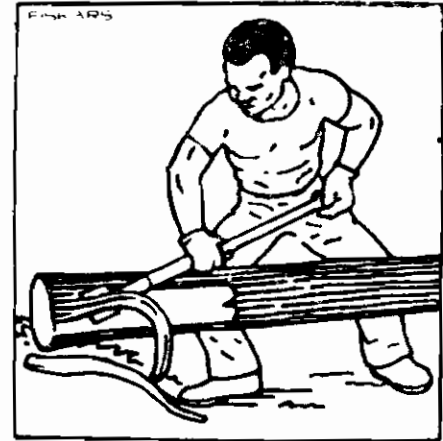

Fig. 4. Begin near the thickest end and work towards the other end.

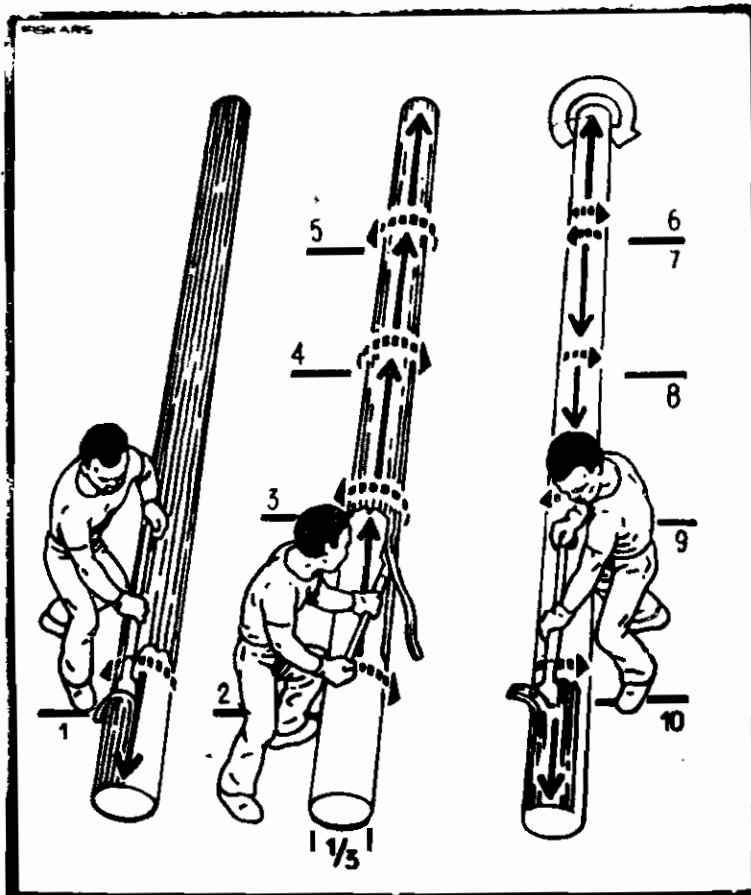

Fig. 5. Debark from each legspread position more than a half circle around the log. Continue the last stroke of each section over to the next section. Then proceed in the direction of the dotted arrow before that section. When you reach the other log end, turn the log and come back the same way.

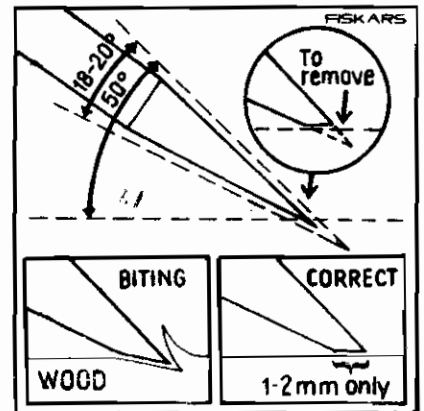

Fig. 6. If the downside edge has been sharpened at exactly the right angle, it will slip easily between the bark and the wood. However, the correct sharpening angle depends on the tree species and several other factors. The basic sharpening angle is about 20°, but right at the point it should be about 50°. It is advisable to sharpen to what you think approximately the right angle, then put the finishing touches to the edge after trying it out a few times when you start the work. If the tool is used frequently, the edge should be honed with a whetstone several times daily.

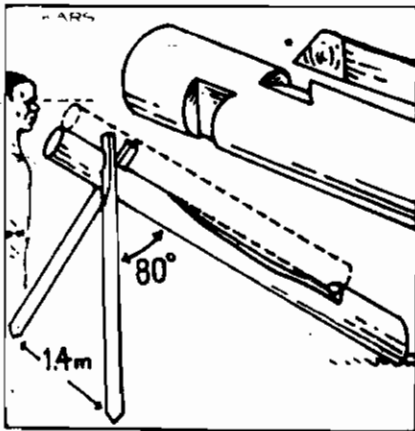

Fig. 7. For debarking with this knife, a solid debarking horse is needed.

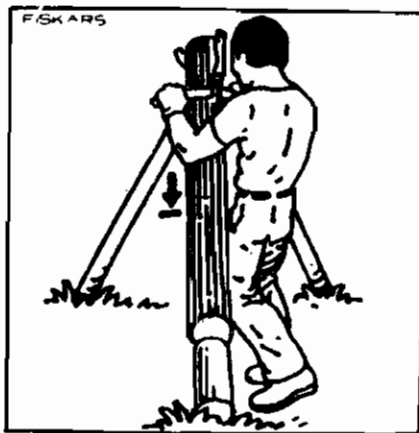

Fig. 8. Begin from the top and pull 4-5 strokes halfway down.

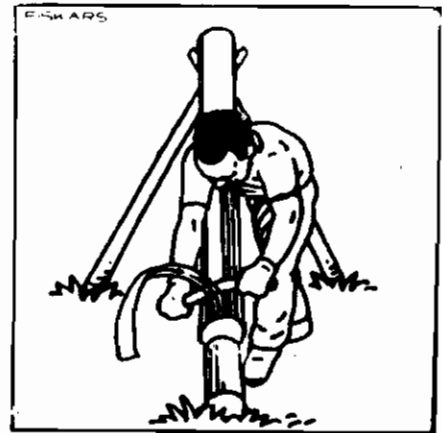

Fig. 9. Turn and push down to the bottom end.



Fig. 10. Turn the log around towards yourself and push 4-5 strokes.



Fig. 11. Turn yourself and pull 4-5 strokes



Fig. 12. Turn the log around towards yourself and use pushing strokes.

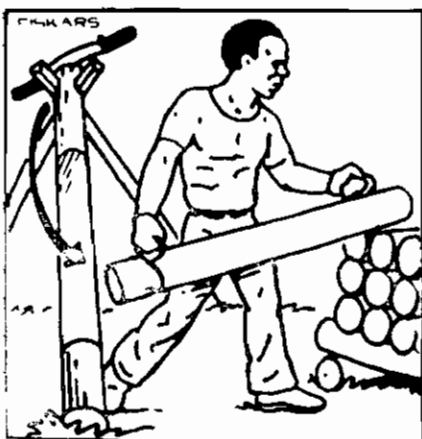

Fig. 13. Lift the log from the debarking horse onto the pile.

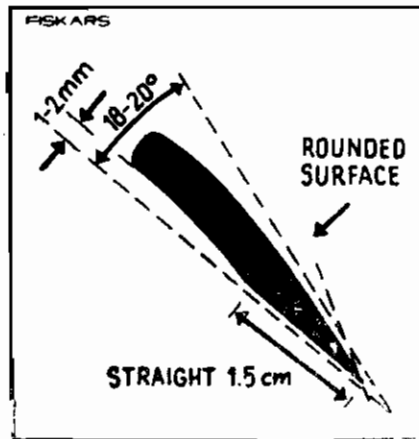

Fig. 14. The upper side of the debarking knife is sharpened into a rounded shape, at an angle of  $20^\circ$ , the down side straight for

about 1.5 cm. If the tool is used frequently, the edge should be honed with a whetstone several times daily. If the upper edge has been sharpened at exactly the right angle, it will slip easily between the bark and the wood. However, the correct sharpening angle depends on the tree species and several other factors. Put the finishing touches to the upper edge after trying it out a few times when you start work.

K. M. BHAT  
Division of Wood Science.



## Our Vanishing Medicinal Trees-4:

### *Saraca asoca* (Roxb) de Wilde (Asoka tree)

*Saraca asoca* (Family Caesalpinaceae), known as 'Asokam' in Malayalam is a small to medium sized evergreen tree distributed throughout India upto an elevation of about 750 meters. But in Kerala, at present, it is seen growing naturally only in some parts of the forest areas.

The bark of this tree is astringent and acidulous. The decoction of the bark gives a greenish precipitate with Ferric chloride and brownish sediment with solution of iodine in Potassium iodide. The bark is reported to contain tannins, catechol, haematoxylin,

ery, scabies in children, inflammation and enlargement of cervical glands, excessive thirst and burning sensation. Flowers are also used in the preparation of an excellent uterine tonic. Seeds are used in treating bone fractures.

Asoka tree, with an erect trunk and greyish to dark brown scabrous bark, attains a height of about 6-12 meters and diameter of about 20-30 cm. The branches which are somewhat droopy bear nearly sessile, large, abruptly pinnate leaves: 30-60 cm long having 3-6 pairs of large oblong lanceolate leaflets, 15-20 cm long copper coloured when young. Flowers, appearing during January to March, are apetalous, large, showy, yellow in colour when just open but change to red gradually. Sepals are unequal in size and petaloid. Thalamus tube is elongated and cylindrical. Stamens are varying in number from 5 to 8. Ovary is superior unilocular and multi-ovuled; style is long with capitate stigma. Fruits which appear from May onwards, are woody, smooth, black, turgid pods with 4-8 seeds per pod. Seeds are ellipsoid oblong and compressed.

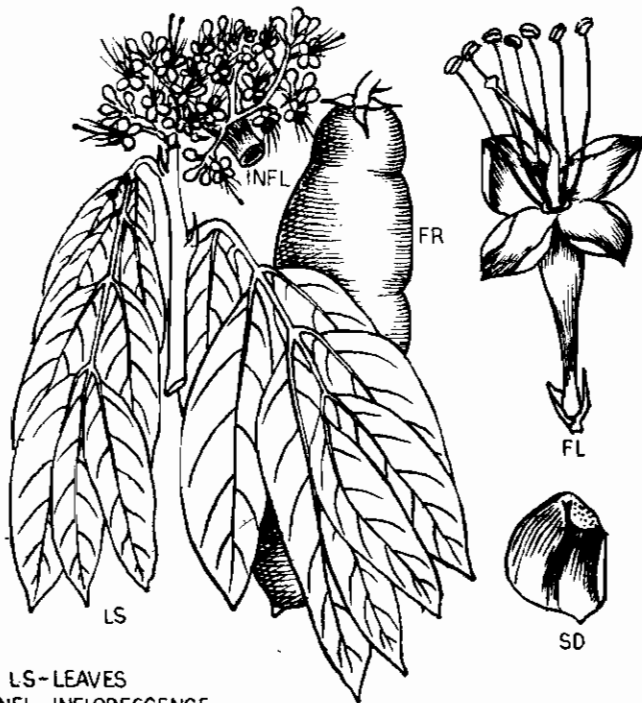

LS-LEAVES  
INFL-INFLORESCENCE  
FL-FLOWER  
FR-FRUIT  
SD-SEED

ketosterol, a crystalline glycosidal constituent, a saponin, an organic calcium compound and an inorganic iron compound. The activities of the drug appear to be due to the presence of the steroidal component and the calcium salt. The aqueous extract of the bark is useful in the treatment of uterine bleeding, especially menorrhagia, biliousness, dyspepsia, dysentery, piles, ulcers and pimples. Leaves have blood purifying properties and their juice mixed with cumin seeds is used for treating stomach ache. Flowers are used for treating bleeding piles, dysent-

Wood of *Saraca asoca* is pale yellowish-brown, moderately hard and heavy, straight grained, with texture medium to coarse. Sapwood and heartwood are not distinct. The wood is often used for carving and for making agricultural implements.

For artificial propagation, seeds may be sown in nursery beds during June-July and lightly covered with soil. Slight shade and regular watering are required to facilitate germination. Germination begins within a fortnight and continues for a month. The seedlings can be transplanted in the field when they are three months old.

As the tree yields very valuable raw material for Ayurvedic medicines, its unscientific exploitation had led to scarcity. Due to unavailability of sufficient Asoka bark it is often adulterated with *Polyalthia* species. To meet the demand and ensure the genuineness of the raw material it has become essential to raise plantations of Asoka in Kerala.

V. P. K. Nambiar  
Division of Botany (Plant Taxonomy)

# Books of Interest

**ORCHIDS OF INDIA.** By T. K. Bose and S. K. Bhattacharjee, XXIII + 538 p., 47 + 16 pl. 347 fig. Naya Prakash, 206 Bidhan Sarani, Calcutta 700006, India. Rs. 550-00

Eventhough Orchidaceae is the third largest family of flowering plants in India and many of the orchids are of horticultural and floricultural importance, our present knowledge about this group of plants is mostly taxonomical and that too region-wise. This treatise is a pioneer work to account for all the orchids found in India with details on their horticultural aspects. The authors have endeavoured to deal thoroughly with many facets of orchid growing, including the culture methods, apart from adding descriptions and geographical distribution of a large number of native genera, species and their hybrids.

The book which includes 860 species of orchids belonging to 132 genera is of wide interest as orchid growing has become not only a hobby but also a business in many developing countries. India, with diverse climatic conditions is one of the largest natural abodes of orchids, many of which can easily be grown on a large scale in orchid farms. In this context, chapters on different uses of orchids with their genera-wise distribution in India and methods of propagation and cultivation will be very useful. Elucidation of the optimum temperature, light, humidity, water requirements, methods of multiplication (both *in vivo* and *in vitro*), potting methods, media and compost, manuring techniques and details of pests and diseases attacking orchids in cultivation, which all form part of large scale orchid growing, is of ample practical value. The details given on the designing of orchid house with excellent photographs and first hand information on other aspects of orchidarium management are of utmost importance to orchid growers.

Considering the usefulness of this book, certain errors and omissions in the text are of minor importance. For example, no attempt has been made to render the nomenclature of the various taxa up-to-date and synonyms are not consistently used except for a few alternate names given for some genera. Orthography and author citations of many genera are wrong like *Didicea* King & Pantl. instead of *Didicea* King & Prain (p. 237) and *Epipogum* L. C. Rich. instead of *Epipogium* R. Br. (p. 249). Author names like Bruhl (p. 143), D. Don (p. 241), Duthie (p. 183) and Prain (p. 417) which are not abbreviated are

given with full-stops. Similarly joint authors like Blatter and Mc Cann (p. 385) are not connected by 'et' or 'and' and wherever such signs are used they are not given uniformly e. g. Par. & Rchb. f. (p. 263) and Par. and Rchb. f. (p. 262). Varietal epithets in many instances start with capital letters like *Satyrium nepalense* D. Don Var. *Ciliata* Ldl. (p. 486) which is also not correct.

A few genera like *Acriopsis* Reinw. ex Blume and species like *Ania viridifusca* (Hook. f.) Tang et Wang and *Ephemerantha macraei* (Lindl.) Hunt et Summerh. which are distributed in the eastern parts of India does not find a place in the book.

Photographs and line-drawings are good. But as they are not numbered, to refer to them in any future work is rather difficult. Moreover the line-drawings of plants and their parts are given without any scale. The index to botanical names given at the end of the book may have been avoided as the various genera and species are arranged alphabetically in the text.

On the whole the book is nicely brought out and is almost free from printing mistakes and those errors or omissions mentioned here does not at all reduce the usefulness of the work as a ready reference tool for both orchid growers and taxonomists.

K. K. N. Nair  
Division of Botany (Plant Taxonomy)

## "PLUS TREE" MONTH - APRIL 1983

Kerala Forest Research Institute and the Silvicultural Research Division of the Kerala Forest Department are jointly organising a plus tree month in April, 1983. It is intended to organize such search every year in the month of April. The aim of the endeavour is to organise a month's search for the outstanding trees in our forests having desirable genetic traits. These selected trees will be included in the genetic improvement programme. This year it is planned to look for the following trees:

- 1 *Tectona grandis*
- 2 *Bombax ceiba*
- 3 *Ailanthus triphysa*
- 4 *Gmelina arborea*
- 5 *Eucalyptus grandis* and *E. tereticornis*

Your active co-operation in the search is solicited. If you locate an outstanding tree you may kindly intimate it to the Geneticist, KFRI, Peechi, Trichur.

Genetics Division

# Multipurpose River Valley Project

Although hydroelectric projects are considered to be one of the safest and cheapest sources of harnessing energy, their impact on environment, especially on flora and fauna is a matter of controversy. Construction of a dam across the Periyar river has created a 'v' shaped reservoir with a maximum depth of about 150 meters. It is reported that submersion of the valley, which had thick forest cover, has affected considerably the population of wild animals and composition of forest. Since no basic data on such impacts of hydroelectric project on the environment was available an, inter-institutional, multidisciplinary study titled Multipurpose River Valley Project (MRVP) was initiated in 1981 by the Department of Environment, Government of India. Idukki Hydroelectric Project is taken up as a case study.

The MRV Project involves independent studies on remote sensing (National Remote Sensing Agency), hydrology and seismology (Kerala State Electricity Board, Research Wing), ground water regime (Central Ground Water Board), study of physical systems (Kerala State Water Pollution Board), fauna (Zoological Survey of India), flora (Botanical Survey of India), Geology and Geomorphology (Centre for Earth Science Studies) and ecology of larger mammals with reference to availability of resources (Kerala Forest Research Institute).

The area of research work entrusted to Kerala Forest Research Institute is jointly handled by the Divisions of Wildlife Biology and Ecology. The work was commenced during late 1981 with the following objectives:

- (i) to estimate the population and study the behavioural changes of one herbivore (elephant), one carnivore (wild dog) and one primate (bonnet monkey),
- (ii) to study the physiognomy and floristic composition of different forest types encountered in the study area,
- (iii) to gather phenological data on the availability of plant produce,
- (iv) to study the microclimatic conditions *In situ* and,
- (v) to work out the disturbance index.

## RECENT PUBLICATIONS

### Published in journals

Sharma, J. K. and C. Mohan 1982. *Cylindrocladium* spp. associated with various diseases of *Eucalyptus* in Kerala. Eur. J. For. Path. 12: 126-136.

**Abstract:** During an extensive survey of nurseries and plantations spread throughout the state seven species of *Cylindrocladium* were found to be associated with various diseases of *Eucalyptus* spp. *C. quinqueseptatum* was the dominant species followed by *C. illicicola*, *C. floridanum*, *C. parvum*, *C. curvatum* and *C. scoparium*. *C. quinqueseptatum* was isolated from the specimens collected throughout Kerala irrespective of host species or geographical location. However, other species had discernible spatial distribution with a narrow host range. *C. floridanum* and its perfect stage *Colonectria floridana*, *C. curvatum* and *C. clavatum* are reported for the first time on *Eucalyptus* in India.

Ghosh S. K., Balasundaram, M. and Mohammed Ali, M. I. 1982. Chemical control of *Dendrophthoe falcata* on teak through tree injection. A preliminary field study. Current Science 51 (23): 1119.

**Abstract:** Using the tree infusion technique developed by the division selective killing of *Dendrophthoe falcata* var. *pubescens* Hook. f. which is one of the most destructive parasite on teak was attempted. Among the weedicides tested Sencor (Metribuzin) supplied by Bayer Ltd. gave encouraging results when applied at 600 ml of 0.25% a. i. After 2 months parasites on the trees were dead and no harmful effect was found on host trees even after one year.

### KFRI Research Reports

Varma, R. V. Investigations on the possibility of non-insecticidal control of termites. KFRI Research Report No. 11 - Final Report of the Research Project Entom 06/79, June 1982. 28 p.

**Abstract:** Effective control of termites is usually achieved by long persistent synthetic pesticides like

---

Detailed studies on the project are in progress and the work is expected to be completed by June 1984. It is hoped that the consolidation of these areas of work at the conclusion of this study will bring out a clear picture of the impact of hydroelectric project on the ecology of the area.

Divisions of Wildlife Biology and Ecology

aldrin, chlordane or heptachlor. The possibility of replacing these chlorinated hydro-carbons by some non-insecticidal methods of control were investigated in this study.

To test the effect of various substances, methods were developed for maintaining subterranean termites under laboratory conditions. The termite, *Odontotermes guptai* Roonwal and Bose was successfully maintained in B. O. D. incubator at  $\pm 1^\circ\text{C}$  in glass jars for about 6 months.

*Eucalyptus* seedlings upto about 1 year old are highly susceptible to attack by termites which feed on the roots. Investigations showed that the roots contained some substance which was attractive to termites. Extracts of the roots prepared in acetone and alcohol were found active as attractants in bioassay. Chemical characterization of the eucalypt root extract showed the active substance to be a phenolic acid. Further identification of the compound was not attempted. Attractancy of eucalypt root extract was not sufficiently strong to warrant testing under field conditions. Root extract of rubber seedling, on the other hand was not attractive.

Alexander, T. G. and Thomas P. Thomas. Cultural practices for managing soil erosion in forest plantation: A state of knowledge report. KFRI Research Report No. 14. Final Report of Research Project. Soils 05/1981. December 1982, 11 p.

**Abstract:** Soil erosion is a phenomenon that has existed throughout geological time, but lately human activities have accelerated it. It continues at slow rate in natural forests, but soil disturbances by several operations promote erosion in forest plantations. Though mechanical and cultural methods are available for erosion control, current view is that low-cost cultural conservation practices are appropriate in forest plantations. This project was launched for preparation of a state-of-knowledge report on cultural practices suitable for managing soil erosion in forest plantations with special reference to Kerala.

Soil loss in a region is the function of climate, soil erodibility, topography, vegetation cover and anti-erosion measures. While mechanical and cultural methods are accessible for erosion control, effects of the former are short-lived unless measures are taken to reduce exposure of soil to raindrops. Further, under tropical conditions a vegetation of mulch cover is the key factor in erosion management.

An overview reveals that use of grass-legume mixtures, cover and under crops, mulches, minimum and zero tillage, contour cropping, gully control by vegetation and afforestation are the major cultural practices.

In low-input forest plantations, prevention is better than cure approach is apt and here erosion management requires proper action at the proper time. As the time of worst vulnerability to erosion is during establishment period, maintenance of cover by taungya crops, undergrowth, under crops or mulches is crucial. Contour planting of seedlings and use of ridge and furrow system for tapioca planting can minimize erosion in forest plantations. Also, inter-crops which provide good cover namely *Leucaena leucocephala*, *Calliandra calothyrsus* and *Aecia auriculiformis* may be tried during the post-taungya period to alleviate harmful effects of erosion.

### KFRI Seminar Proceeding

Proceedings of the Seminar on Medicinal Plants held on 17th December 1981 at Kerala Forest Research Institute, Peechi-Division of Botany (Plant Taxonomy).

#### For KFRI Publications

write to:

Librarian

KFRI

Peechi, -680 653

□  
"Without a firm foundation  
in basic knowledge,  
innovation perceived as  
advances are hollow  
and invariably collapse".

—Arthur Kornberg

□

## SEMINAR, CONGRESS, LECTURES.....

### INTERNATIONAL MEETINGS

Dr. S. Kedharnath, Director, attended the "Technical consultation meeting on wood based panels for Asia and Pacific region held at Delhi, 13-17 January, 1983.

Dr. R. V. Varma (Entomology) participated in the International study workshop on Termite Caste Differentiation held at Nairobi, Kenya, 7-12 November 1982, on an invitation from the International centre of Insect Physiology and Ecology (ICIPE).

Dr. K. Balasubramanyan (Ecology) and Dr. S. Sankar (Soil Science) attended the Symposium on 'Resources Survey of land use planning and Environmental conservation' at Dehra Dun, 20-22 October, 1982. Dr. Balasubramanyan presented a paper entitled "Need for a clear land policy — A case study in Attappady, Palghat District, Kerala."

Dr. J. K. Sharma (Plant Pathology-F) participated in a symposium on "Fungi in Forest ecosystem" organised by Mycological Society of India at Sardar Patel University, Vallabh Vidya Nagar, Gujarat, 6-7 December 1982 and delivered a special invited talk on "Potential threat of diseases caused by native pathogens in the establishment of exotics with special reference to *Eucalyptus* in Kerala.

Dr. A. R. R. Menon (Ecology) attended a short term course on "Landscape planning and Environmental conservation" at school of Planning and Architecture, New Delhi, 9-23, December, 1982

Dr. R. Gnanaharan (Wood Science) attended the following meetings of the Indian Standards Institutions in December 1982, at New Delhi.

- i. Timber seasoning and treatment sub committee BDE 9 : 3.
- ii. Timber testing sub committee BDE 9 : 9.
- iii. Timber conservation and grading sub committee BDE 9 : 10.

Kum. M. V. Mary (Soil Science), Shri. M. I. Mohammed Ali (Pathology non-fungal) Shri. C. Mohan (Pathology Fungal), Smt. K. K. Seethalakshmy (Physiology), and Shri. T. Surendran (Physiology) attended the Plantation Crops Symposium (PLA-CROSYM-V) at CPCRI, Kasargode, 14-18 December 1982. Shri. C. Mohan presented a paper entitled

"A serious disease of *Anacardium occidentale* L. caused by *Cylindrocladium camelliae* and its possible control" by C. Mohanan and J. K. Sharma.

Prof. V. P. K. Nambiar (Botany Taxonomy) attended the Ayurvedic Seminar conducted by the Arya Vaidyasala, Kottakkal on 20 January 1983.

Shri C. N. Krishnankutty (Statistics) attended the seminar on "Data base of the Kerala Economy" organised by Directorate of Economics and Statistics in collaboration with the State Planning Board and the Centre for Development Studies, 27-28 January 1983 at Trivandrum and Presented a paper entitled "Forestry Planning in Kerala : Do we have adequate data?" by C. T. S. Nair and C. N. Krishnankutty.

### KFRI Seminars...

- Dr. C. S. Venkatesh : Some promising new techniques for clonal propagation of bamboos, (6 October, 1982).
- Dr. S. Kedharnath : Forest tree improvement and its potential in Indian Forestry. (December, 1982)
- Dr. T. G. Alexander : A century of Soil Science - an overview. (31 January, 1983).
- Dr. P. Vijayakumaran Nair : Studies on the development of behaviour in asiatic elephant. (14 February, 1983).
- Dr. R. V. Varma : Caste differentiation in termites (28 February, 1983).
- Shri. K. K. Ramachandran : Radiotelemetry in wildlife study. (14 March, 1983).
- Shri J. C. Varmah, I F S (Retd.), Ex-President, FRI & Colleges, Dehra Dun : Forestry in Andamans (20 January 1983).
- Shri K. M. Tiwari, I F S, President FRI & Colleges, Dehra Dun : Forestry education and research in India. (2 February, 1983).
- Shri R. H. Kemp, ODA Forestry Adviser, U. K. : Some aspects of tropical forestry. (4 February, 1983).



## Forthcoming events of 1983

April 11-12. INDIA National Symposium on Advances in Tree Sciences, Forest Research Inst., Dehra Dun.

Ref: Dept. of Forestry, Himachal Pradesh Vishwa Vidyalyaya, P. O., Nauni 173 230, Solan Distt.

May 9-13. AUSTRALIA. 14th Annual meeting of the International Research Group on Wood Preservation.

Ref: H. Greaves, P. O. Box 56, Highett, Victoria 3190.

May 23-27 U S A Bioenergy '83: Second World Congress and exposition, Atlanta, GA.

Ref: Bioenergy Council 1625 Eye St., N. W. Suite 825 A, Washington D. C. 20006.

May FRANCE. 5th International Congress on Medicinal Plants.

Ref: Prof. J. Jolivet, Faculte'de Medicine 16bd, Davier, F-49000, Angres.

June 17-24. CANADA. 20th Congress of International Seed Testing, Ottawa.

Ref: K. Kamra, Soeriges Landbruksuniversitet, 590183, Umea, Sweden.

June 27-July 7. U. S. A. IUFRO, Division 5 (Forest Products and Timber Utilization), Madison.

Ref: C/o CMM Inc, P. O. Box 5246, Madison, Wisconsin 53705.

Aug. 17-24. AUSTRALIA. IV International Congress of Plant Pathology, Melbourne

Ref: Dr. G. Weste, Univ. of Melbourne, Parkville Victoria 3052.

Aug. 28-3. Sept. JAPAN. 3rd International Mycological Congress, Tokyo.

Ref: Prof. K. Tubaki. C/o International Congress Service Inc, Chikusen Bldg. 5F 2-7-4, Nihombashi, Cho-Ku, Tokyo, Japan 103.

Aug. 22-26. SWEDEN. 3rd European Ecological Symposium on Plant-animal interaction, Lund.

Ref: 3rd Eur. Ecol. Symp. Ecology Bldg., S-223 62, Lund.

Aug. 22-26. INDIA. International Conference on Biometeriology, Vigyan Bhavan, New Delhi.

Ref: Prof S. C. Pandeya, Dept. of Biosciences, Saurashtra University, Rajkot 360 005, Gujarat.

Sept. 11-16. NIGERIA. VII International Symposium on Tropical Ecology.

Ref: Dr. A. Edward, Dept. of Biological Sciences, Univ. of Lagos, Akoka, Yaba, Nigeria.

Sept. 19-23. THE NETHERLANDS International Symp. on Afforestation.

Ref: J. Driver, P. O. Box 88, 6700 AB, Wageningen.

October 2-6. W GERMANY. IAWA/IUFRO Wood Anatomy Meeting, Hamburg.

Ref: Dr. Pieter Baas, Rijksherbarium, P. O. Box 9514, 2300 Ra Leiden, The Netherlands.

Nov. 20-25. U. K. Xth International Congress of Plant Protection. Brighton.

Ref. Mrs. R. A. Bishop, Conference Planners Ltd., 144/150 London Rd., Cryodon CRO 2 DT, Surrey, UK.

December INDIA. 15th International Congress of Genetics, New Delhi.

Ref: Prof V.L. Chopra, XV Congress of Genetics, P. O. Box 2841, New Delhi 110 060.

□

---

### Campus news \* Campus news

---

#### VISITORS

Dr. I. A. S. GIBSON, — 7 October, 1982  
Consultant Forest Pathologist,  
E. Sussex, U. K.

Mr R. H. KEMP, — 4 February, 1983  
Forestry Advisor, Overseas  
Development Administration,  
London, U. K.

Prof. L. ROCHE, — 26 February, 1983  
Dept. of Forestry & Wood Science,  
University College of North Wales,  
Bangor, U. K.

### Joined KFRI recently

#### Scientific Staff

K. T. Philip M.Sc.	—	Research Fellow (DST Project)
K. K. Ravindranathan M.Sc.	—	Research Fellow (DST Project)
S. Yatheesh M.Sc.	—	Research Fellow (DST Project)
R. Chandrasekharan Pandalai M.Sc.	—	Research Assistant (Silviculture)
Nandakumar U. Narath M.Sc.	—	Research Assistant (Silviculture)

#### Technical Staff

Jose Thomas B.Sc.	—	Field Assistant (DST Project)
-------------------	---	----------------------------------

#### Administrative Staff

P. Achuthankutty B.Sc.	—	P.A. to the Director
C. V. Jose	—	Stenographer
P. R. Jose	—	Sergeant
K. C. Subramanian	—	Watcher
A. C. Antony	—	Watcher

### Left KFRI recently

#### Scientific Staff

C. S. Venkatesh Ph.D.	—	Scientist (Genetics)
Y. Salahuddin M.Sc.	—	Research Fellow (DST Project)
K. Somasekharan Unnithan M Sc.	—	Research Fellow (DST Project)

### KFRI Staff Council - Constituted

To enhance co-operation and increase efficiency in service combined with welfare of employees, a staff council has been constituted, to function as an advisory body to make recommendations to appropriate authorities. The staff council has following members:-

#### Ex-officio members

1. Director
2. Registrar
3. Dr. C. T. S. Nair (Senior most Scientist nominated by the Director)

#### Representatives of the Staff

Scientific	:	1. Sri. C. Mohan 2. Sri. M. Balasundaram
Administrative	:	1. Sri. M. K. Aravindakshan 2. Sri. C. Radhakrishnan
Technical	:	1. Sri. Subash Kuriakose 2. Sri. Y. Yesodharan

## OBITUARY

### Prof. B. SIVARAO

(1924-1983)

It is with profound sadness we announce the death of Prof. SIVARAO on March 28, 1983. He was 59.

In the death of Prof. Rao, the field of Wood Science has lost an eminent Scientist. Prof. Rao took his Ph.D. in Wood Anatomy from the University of London in 1959. He initiated work on Wood Anatomy and Wood Pathology in the Andhra University where he headed the Department of Botany for many years. It was because of Prof. Rao's initiative and foresight, Andhra University is one of the few Universities in India which offer post-graduate level courses in the field of Wood Science. The Institute was fortunate to have his leadership and counsel in setting up the Wood Science Division. He was heading the Division from April 7, 1980 to April 22, 1981.

May God comfort his bereaved widow and other members of his family.

R. G.

## **KFRI Employees' Co-operative Society inaugurated**

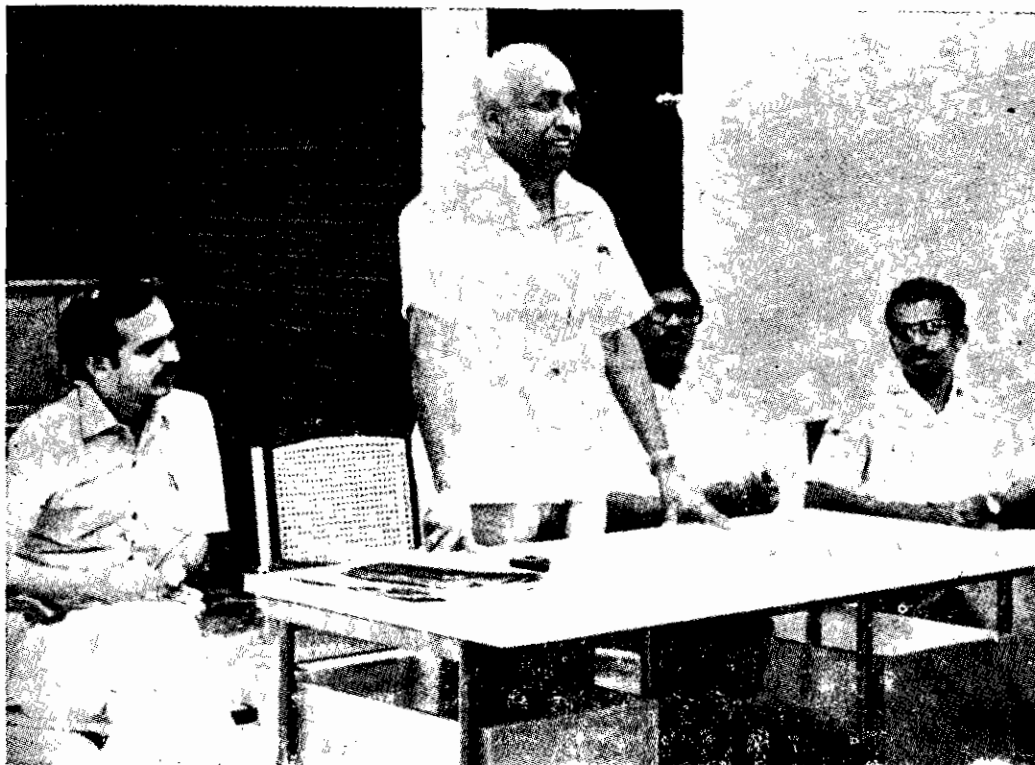

The KFRI Employees' Co-operative Society Ltd. No. R. 718 was officially inaugurated by the Director, Dr. S. Kedharnath on 1st March 1983.

The main objective of the Society is to raise funds by way of shares or deposits from the individuals and give loans to the needy members. The Society is also intending to start a co-operative store for distribution of consumer items at a fair price. Besides, in due course the society will expand its sphere of activities.

The members of the managing committee of the Society are Dr. R. V. Varma, Sri K. Ravindran, Sri A. Ramakrishnan, Sri P. K. Sankaran Unni, Sri. E. V. Ishac, Sri A. R. Rajan and Smt. M. Kamalamma.